SPS-73200W-DXXG / SPS-73200BW-DXXG / SPS-73200AW-DXXG (RoHS Compliant)
1.25Gbps / 200km / 100GHz DWDM Digital Diagnostic LC SFP SINGLE-MODE TRANSCEIVER

FEATURES

- Hot-Pluggable SFP Footprint LC Optical Transceiver
- Small Form-Factor Pluggable (SFP) MSA compatible
- Compliant with IEEE 802.3z Gigabit Ethernet
- Compliant with Fibre Channel FC-PI 100-SM-LL-V
- Distance up to 200km
- Temperature-stabilized DWDM DML Transmitter
- 41 dB Power Budget at Least
- 100 GHz ITU Grid, C Band
- SFF-8472 Digital Diagnostic Function
- AC/AC Coupling according to MSA
- Single +3.3 V Power Supply
- RoHS Compliant
- 0 to 70°C Operation : SPS-73200W-DXXG
- -10 to 85°C Operation : SPS-73200BW-DXXG
- -40 to 85°C Operation : SPS-73200AW-DXXG
- Class 1 Laser International Safety Standard IEC-60825 Compliant

APPLICATIONS

- Gigabit Ethernet Switches and Routers
- Fibre Channel Switch Infrastructure
- XDSL Applications
- Metro Edge Switching
- CPRI option 2: 1228.8 Mbit/s
- CPRI option 1: 614.4 Mbit/s
- OBSAI 768 MBaud

DESCRIPTION

The SPS-73200W-DXXG series single mode transceiver is a small form factor pluggable module for bi-directional serial optical data communications such as Gigabit Ethernet 1000BASE-ZX and Fibre Channel FC-PI 100-SM-LL-V. It is with the SFP 20-pin connector to allow hot plug capability. Digital diagnostic functions are available via an I²C. This module is designed for single mode fiber and operates at a nominal wavelength of 100GHz ITU Grid, C Band DWDM wavelength. A guaranteed minimum optical link budget of 41 dB is offered. The transmitter section uses temperature-stabilized DWDM directly modulated laser (DML) and is class 1 laser compliant according to International Safety Standard IEC-60825. The receiver section uses an integrated InGaAs Avalanche photodetector preamplifier mounted in an optical header and a limiting post-amplifier IC.

LASER SAFETY

This single mode transceiver is a Class 1 laser product. It complies with IEC-60825 and FDA 21 CFR 1040.10 and 1040.11. The transceiver must be operated within the specified temperature and voltage limits. The optical ports of the module shall be terminated with an optical connector or with a dust plug.

ORDER INFORMATION

P/No.	Bit Rate (Gb/s)	1000BASE	Distance (km)	Spacing (GHz)	Wavelength (nm)	Package	Temp (°C)	RoHS Compliant
SPS-73200W-DXXG	1.25		200	100	DWDM*	LC SFP with DMI	0 to 70	Yes
SPS-73200BW-DXXG	1.25		200	100	DWDM*	LC SFP with DMI	-10 to 85	Yes
SPS-73200AW-DXXG	1.25		200	100	DWDM*	LC SFP with DMI	-40 to 85	Yes

*: XX: 100GHz ITU Grid wavelength (Please see below)

Channel #	Product code	Frequency (THz)	Center Wavelength (nm)	Label
20	SPS-73200W-D20G	192.0	1561.42	D20
21	SPS-73200W-D21G	192.1	1560.61	D21
22	SPS-73200W-D22G	192.2	1559.79	D22
23	SPS-73200W-D23G	192.3	1558.98	D23
24	SPS-73200W-D24G	192.4	1558.17	D24
25	SPS-73200W-D25G	192.5	1557.36	D25
26	SPS-73200W-D26G	192.6	1556.55	D26
27	SPS-73200W-D27G	192.7	1555.75	D27
28	SPS-73200W-D28G	192.8	1554.94	D28
29	SPS-73200W-D29G	192.9	1554.13	D29
30	SPS-73200W-D30G	193.0	1553.33	D30
31	SPS-73200W-D31G	193.1	1552.52	D31
32	SPS-73200W-D32G	193.2	1551.72	D32
33	SPS-73200W-D33G	193.3	1550.92	D33
34	SPS-73200W-D34G	193.4	1550.12	D34
35	SPS-73200W-D35G	193.5	1549.32	D35
36	SPS-73200W-D36G	193.6	1548.51	D36
37	SPS-73200W-D37G	193.7	1547.72	D37
38	SPS-73200W-D38G	193.8	1546.92	D38
39	SPS-73200W-D39G	193.9	1546.12	D39
40	SPS-73200W-D40G	194.0	1545.32	D40
41	SPS-73200W-D41G	194.1	1544.53	D41
42	SPS-73200W-D42G	194.2	1543.73	D42
43	SPS-73200W-D43G	194.3	1542.94	D43
44	SPS-73200W-D44G	194.4	1542.14	D44
45	SPS-73200W-D45G	194.5	1541.35	D45
46	SPS-73200W-D46G	194.6	1540.56	D46
47	SPS-73200W-D47G	194.7	1539.77	D47
48	SPS-73200W-D48G	194.8	1538.98	D48
49	SPS-73200W-D49G	194.9	1538.19	D49
50	SPS-73200W-D50G	195.0	1537.40	D50
51	SPS-73200W-D51G	195.1	1536.61	D51
52	SPS-73200W-D52G	195.2	1535.82	D52
53	SPS-73200W-D53G	195.3	1535.04	D53
54	SPS-73200W-D54G	195.4	1534.25	D54
55	SPS-73200W-D55G	195.5	1533.47	D55
56	SPS-73200W-D56G	195.6	1532.68	D56
57	SPS-73200W-D57G	195.7	1531.90	D57
58	SPS-73200W-D58G	195.8	1531.12	D58
59	SPS-73200W-D59G	195.9	1530.33	D59
60	SPS-73200W-D60G	196.0	1529.55	D60

Absolute Maximum Ratings					
Parameter	Symbol	Min	Max	Units	Notes
Storage Temperature	Tstg	-40	85	°C	
Relative Humidity	RH	5	85	%	Non-condensing
Operating Case Temperature	Topr	0	70	°C	SPS-73200W-DXXG
		-10	85		SPS-73200BW-DXXG
		-40	85		SPS-73200AW-DXXG
Power Supply Voltage	Vcc	-0.5	3.6	V	

Recommended Operating Conditions					
Parameter	Symbol	Min	Typ	Max	Units / Notes
Power Supply Voltage	Vcc	3.13	3.3	3.47	V
Operating Case Temperature	Topr	0		70	°C / SPS-73200W-DXXG
		-10		85	°C / SPS-73200BW-DXXG
		-40		85	°C / SPS-73200AW-DXXG
Relative Humidity	RH	5		85	% / Non-condensing
Power Supply Current	I _{CC(TX+RX)}			430	mA / SPS-73200W-DXXG
				600	mA / SPS-73200B(A)W-DXXG
Data Rate		100	1250		Mb/s

Transmitter Specifications (0°C < Topr < 70°C, 3.13V < Vcc < 3.47V)						
Parameter	Symbol	Min	Typ	Max	Units	Notes
Optical						
Average Launch Power	P _{O,AVG}	+5	---	+8	dBm	1
Center Wavelength Spacing			100		GHz	2
Transmitter Center Wavelength -- over life time	λ _c	X-100	X	X+100	pm	3
Output Spectrum Width	Δλ	---		1	nm	-20 dB width
Side Mode Suppression Ratio	SMSR	30			dB	
Extinction Ratio	E _R	9	---	---	dB	
Optical Rise Time	t _r			260	ps	20% to 80% Values
Optical Fall Time	t _f			260	ps	20% to 80% Values
Relative Intensity Noise	RIN			-120	dB/Hz	
Electrical						
Data Input Current -- Low	I _{IL}	-350			μA	
Data Input Current -- High	I _{IH}			350	μA	
Differential Input Voltage	V _{IH} - V _{IL}	0.5		2.4	V	Peak-to-Peak
TX Disable Input Voltage -- Low	T _{DIS,L}	0		0.5	V	4
TX Disable Input Voltage -- High	T _{DIS,H}	2.0		Vcc	V	4
TX Disable Assert Time	T _{ASSERT}			10	μs	
TX Disable Deassert Time	T _{DEASSERT}			1	ms	
TX Fault Output Voltage -- Low	T _{FaultL}	0		0.5	V	5
TX Fault Output Voltage -- High	T _{FaultH}	2.0		Vcc+0.3	V	5

1. Output power is power coupled into a 9/125 μm single-mode fiber.
2. Corresponds to approximately 0.8 nm.
3. X = specified ITU Grid wavelength
4. There is an internal 4.7K to 10K ohm pull-up resistor to VccTX.
5. Open collector compatible, 4.7K to 10K ohm pull-up to Vcc (Host Supply Voltage).

Receiver Specifications (0°C < Topr < 70°C, 3.13V < Vcc < 3.47V)

Parameter	Symbol	Min	Typ	Max	Units	Notes
Optical						
Sensitivity	Sens			-36	dBm	6
Maximum Input Power	P _{in}	-10			dBm	6
Signal Detect -- Asserted	P _A	---		-36	dBm	Transition: low to high
Signal Detect -- Deasserted	P _D	-50	---	---	dBm	Transition: high to low
Signal Detect -- Hysteresis		1.0	---		dB	
Wavelength of Operation		1100	---	1620	nm	
Electrical						
Differential Output Voltage	V _{OH} - V _{OL}	0.6		2.0	V	
Output LOS Voltage -- Low	V _{OL}	0		0.5	V	7
Output LOS Voltage -- High	V _{OH}	2.0		Vcc+0.3	V	7

- Measured at PRBS 2⁷-1 at BER 1E-12. Receiver sensitivity is better than -35dBm at 1.25 Gbps. However, due to the resolution limitation of DDM, the effect readout range for the RX received power at EEPROM A2 is from -10 to -34 dBm.
- Open collector compatible, 4.7K to 10K ohm pull-up to Vcc (Host Supply Voltage)

CONNECTION DIAGRAM

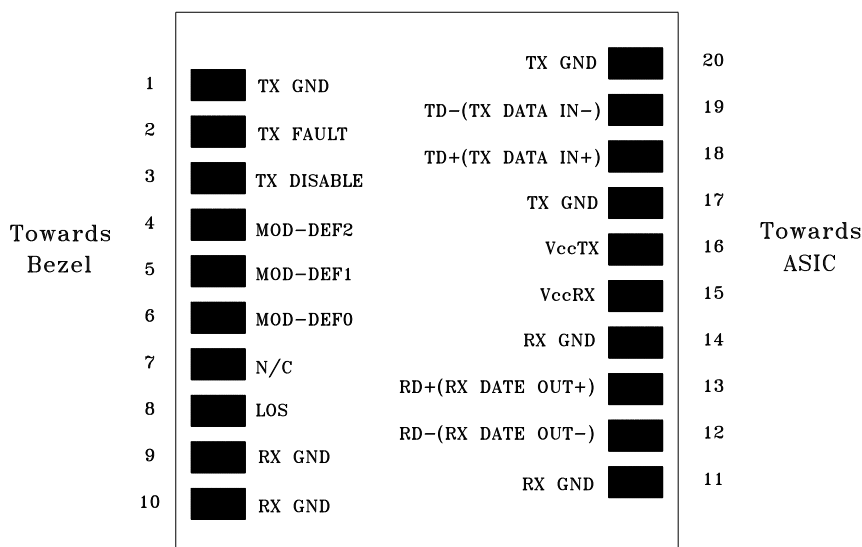

PIN	Signal Name	Description	PIN	Signal Name	Description
1	TX GND	Transmitter Ground	11	RX GND	Receiver Ground
2	TX Fault	Transmitter Fault Indication	12	RX DATA OUT-	Inverse Receiver Data Out
3	TX Disable	Transmitter Disable (Module disables on high or open)	13	RX DATA OUT+	Receiver Data Out
4	MOD-DFE2	Modulation Definition 2 – Two wires serial ID Interface	14	RX GND	Receiver Ground
5	MOD-DEF1	Modulation Definition 1 – Two wires serial ID Interface	15	Vcc RX	Receiver Power – 3.3V±5%
6	MOD-DEF0	Modulation Definition 0 – Ground in Module	16	Vcc TX	Transmitter Power – 3.3V±5%
7	N/C	Not Connected	17	TX GND	Transmitter Ground
8	LOS	Loss of Signal	18	TX DATA IN+	Transmitter Data In
9	RX GND	Receiver Ground	19	TX DATA IN-	Inverse Transmitter Data In
10	RX GND	Receiver Ground	20	TX GND	Transmitter Ground

MODULE DEFINITION

Module Definition	MOD-DEF2 PIN 4	MOD-DEF1 PIN 5	MOD-DEF0 PIN 6	Interpretation by Host
4	SDA	SCL	LV-TTL Low	Serial module definition protocol

Module Definition 4 specifies a serial definition protocol. For this definition, upon power up, SDA and SCL appear as no connection (NC) and MOD-ABS is TTL LOW. When the host system detects this condition, it activates the serial protocol. The protocol uses the 2-wire serial CMOS E²PROM protocol of the ATMEL AT24C01A/02/04 family of components.

RECOMMENDED CIRCUIT SCHEMATIC

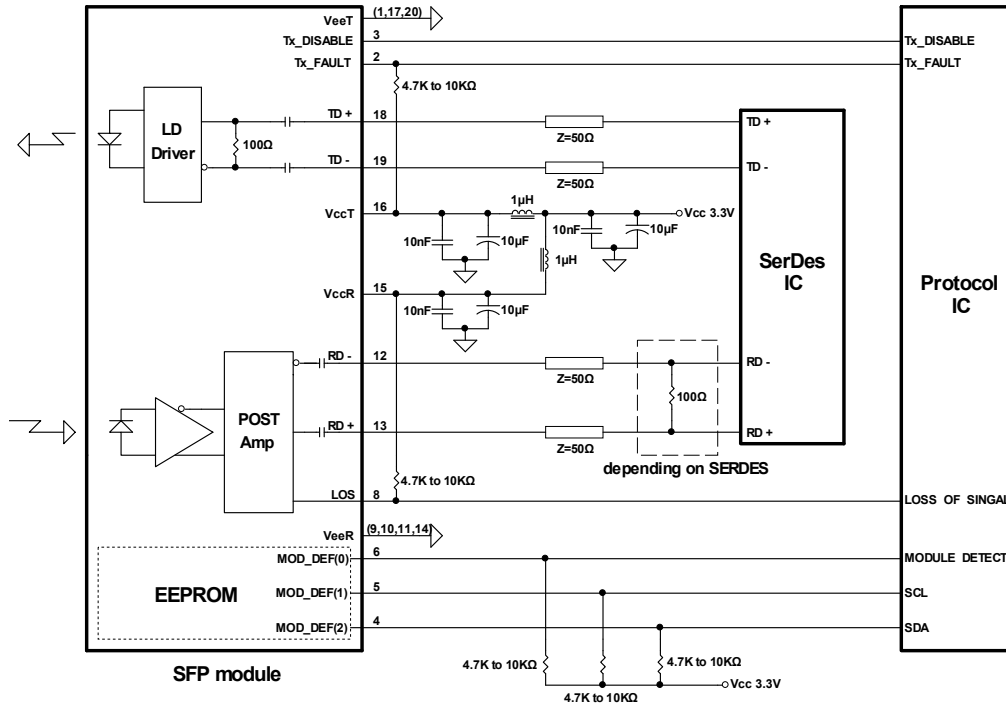

PACKAGE DIAGRAM

Units in mm

Top View

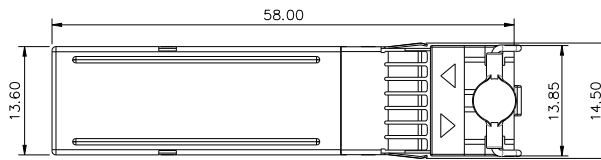

Front View

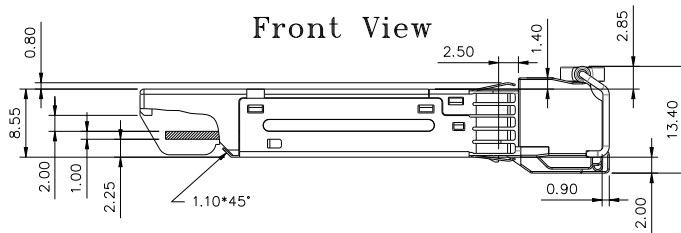

LATCH COLOR
White

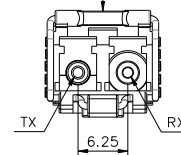

Side View

Bottom View

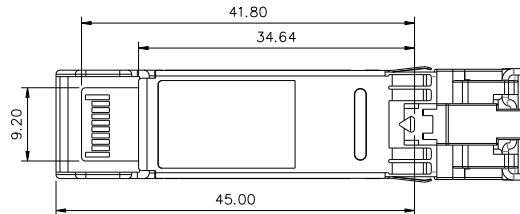

Note: Specifications subject to change without notice.

REVISION HISTORY

Version	Subject	Release Date
1.0	Initial datasheet	2017/7/5
2.0	Add model: SPS-73200BW-DXXG and SPS-73200AW-DXXG	2022/3/17