

BTR-3680G / BTR-3680-SPG

1310 nm TX / 1550 nm RX, 3.3V / 155 Mbps **RoHS Compliant** Single-Fiber Transceiver

FEATURES

- Single Fiber Bi-Directional Transceiver
- 1310 nm LD Transmitter
- 1550 nm Receiver
- Distance up to 80 km
- Industry Standard 1 x 9 Footprint
- Single +3.3 V Power Supply
- RoHS Compliant
- PECL Differential Inputs and Outputs
- 0 to 70°C Operating Temperature: BTR-3680G
- -20 to 85°C Operating Temperature: BTR-3680AG
- Wave Solderable
- Class 1 Laser International Safety Standard IEC-60825 Compliant

APPLICATIONS

- WDM 155 Mb/s Links
- SONET / SDH Equipment Interconnect
- Fast Ethernet 100 Mb/s Links

DESCRIPTION

The BTR-3680G series are high performance modules for single fiber communications by using 1310 nm transmitter and 1550 nm receiver. The transmitter section uses a multiple quantum well laser and is a class 1 laser compliant according to International Safety Standard IEC-60825. The receiver section uses an integrated 1550 nm detector preamplifier (IDP) mounted in an optical header and a limiting post-amplifier IC. A PECL logic interface simplifies interface to external circuitry.

LASER SAFETY

This single mode transceiver is a Class 1 laser product. It complies with IEC-60825 and FDA 21 CFR 1040.10 and 1040.11. The transceiver must be operated within the specified temperature and voltage limits. The optical ports of the module shall be terminated with an optical connector or with a dust plug.

ORDER INFORMATION

P/No.	Bit Rate (Mb/s)	Distance (km)	TX (nm)	RX (nm)	Voltage (V)	Package	Temp. (°C)	TX Power (dBm)	RX Sens. (dBm)	RoHS Compliant
BTR-3680G	125 / 155	80	1310	1550	3.3	1X9	0 to 70	3 to -2	-35	Yes

Note: 1. BTR-XXXXXXG is 1X9 SC receptacle type package.

2. BTR-XXXXX-APBBBG is 1X9 pigtail type package with different connector, A=S is SC connector, A=F is FC connector, A=T is ST connector, A=L is LC connector, A=M is MU connector, BBB is the length of fiber in cm.

Absolute Maximum Ratings					
Parameter	Symbol	Min	Max	Units	Notes
Storage Temperature	Tstg	-40	85	°C	
Operating Temperature	Topr	0	70	°C	
Soldering Temperature	---		260	°C	10 seconds on leads only
Power Supply Voltage	Vcc	0	4.5	V	
Input Voltage	---	GND	Vcc	V	
Output Current	Iout	0	30	mA	

Recommended Operating Conditions					
Parameter	Symbol	Min	Typ	Max	Units / Notes
Power Supply Voltage	Vcc	3.13	3.3	3.47	V
Operating Temperature	Topr	0		70	°C
Data Rate			155	170	Mb/s
Power Supply Current	Icc			260	mA

Transmitter Specifications (0°C < Topr < 70°C, 3.13V < Vcc < 3.47V)						
Parameter	Symbol	Min	Typ	Max	Units	Notes
Optical						
Optical Transmit Power	Po	-2	---	3	dBm	1
Output Center Wavelength	λ	1280		1350	nm	
Output Spectrum Width	$\Delta\lambda$	---	---	2	nm	RMS(σ)
Extinction Ratio	E _R	10	---	---	dB	
Output Eye	Compliant with Bellcore GR-253-CORE and ITU recommendation G.957					
Optical Rise Time	t _r			2	ns	10% to 90% Values
Optical Fall Time	t _f			2	ns	10% to 90% Values
Relative Intensity Noise	RIN			-116	dB/Hz	
Total Jitter	TJ			1.0	ns	2
Electrical						
Data Input Current – Low	I _{IL}	-350			μ A	
Data Input Current – High	I _{IH}			350	μ A	
Differential Input Voltage	V _{IH} - V _{IL}	300			mV	
Data Input Voltage – Low	V _{IL} - V _{CC}	-2.0		-1.58	V	3
Data Input Voltage -- High	V _{IH} - V _{CC}	-1.1		-0.74	V	3

- Notes: 1. Output power is power coupled into a 9/125 μ m single mode fiber.
 2. Measured with a 2²³-1 PRBS with 72 ones and 72 zeros.
 3. These inputs are compatible with 10K, 10KH and 100K ECL and PECL inputs.

Receiver Specifications (0°C < Topr < 70°C, 3.13V < Vcc < 3.47V)						
Parameter	Symbol	Min	Typ	Max	Units	Notes
Optical						
Sensitivity	---	---	---	-35	dBm	1
Maximum Input Power	Pin	-3		---	dBm	
Signal Detect -- Asserted	Pa	---	---	-35	dBm	Transition: low to high
Signal Detect -- Deasserted	Pd	-43	---	---	dBm	Transition: high to low
Signal detect -- Hysteresis		1.0	---	4.0	dB	
Wavelength of Operation		1480	---	1580	nm	2
Electrical						
Data Output Voltage – Low	V _{OL} - V _{CC}	-2.0		-1.58	V	3
Data Output Voltage – High	V _{OH} - V _{CC}	-1.1		-0.74	V	3
SD Output Voltage -- Low	V _{OL} - V _{CC}	-2.0		-1.58	V	3
SD Output Voltage -- High	V _{OH} - V _{CC}	-1.1		-0.74	V	3

- Notes: 1. Minimum sensitivity and saturation levels at BER=1E-10 for a 2²³-1 PRBS with 72 ones and 72 zeros.
 2. At least 30 dB optical isolation for the wavelength 1260 to 1360 nm.
 3. These outputs are compatible with 10K, 10KH and 100K ECL and PECL outputs.

CONNECTION DIAGRAM

Receiver Signal Ground	1 (Rx GND)	○
Receiver Data Out	2 (RD+)	N/C
Receiver Data Out Bar	3 (RD-)	
Signal Detect	4 (SD)	
Receiver Power Supply	5 (Rx Vcc)	
Transmitter Power Supply	6 (Tx Vcc)	
Transmitter Data In Bar	7 (TD-)	
Transmitter Data In	8 (TD+)	N/C
Transmitter Signal Ground	9 (Tx GND)	○

TOP VIEW

PIN	Symbol	Notes
1	Rx GND	Directly connect this pin to the receiver ground plane
2	RD+	See recommended circuit schematic
3	RD-	See recommended circuit schematic
4	SD	Active high on this indicates a received optical signal
5	Rx Vcc	+3.3V dc power for the receiver section
6	Tx Vcc	+3.3V dc power for the transmitter section
7	TD-	See recommended circuit schematic
8	TD+	See recommended circuit schematic
9	Tx GND	Directly connect this pin to the transmitter ground plane

RECOMMENDED CIRCUIT SCHEMATIC

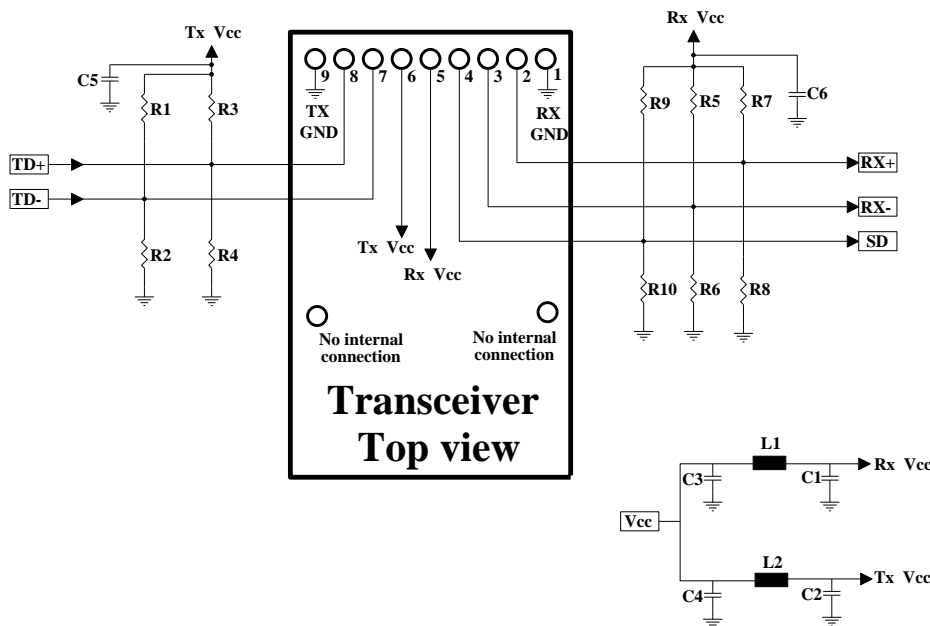

R1=R3=R5=R7=R9=130 ohm
R2=R4=R6=R8=R10=82 ohm
C1=C2=C3=C5=C6=0.1 Uf
C4=10uF L1=L2=1uH

The split-load terminations for ECL signals need to be located at the input of devices receiving those ECL signals. The power supply filtering is required for good EMI performance. Use short tracks from the inductor L1/L2 to the module Rx Vcc and Tx Vcc. A GND plane under the module is required for good EMI and sensitivity performance.

PACKAGE DIAGRAM

Units in mm

1) Receptacle Type

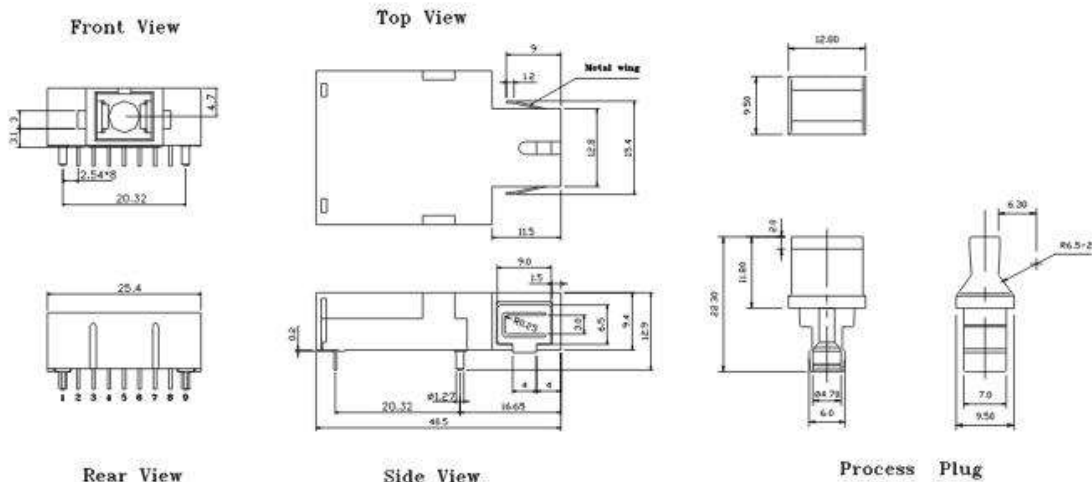

BTR-3680G

2) Pigtail Type

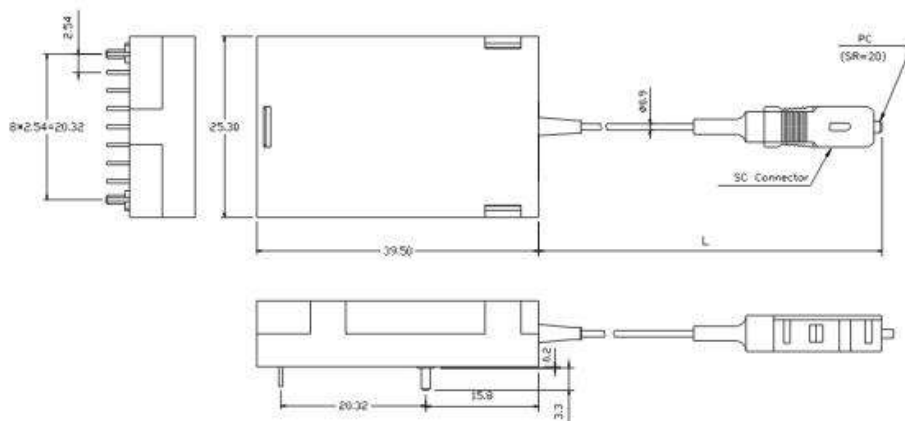

BTR-3680-SP50G

Note: Length L is 50±3 cm. Other pigtail's length is available upon request.

Note: Specifications subject to change without notice.