

SPS-9350V-1T1RG

(RoHS Compliant)

1550 nm / 3 Gb/s Medium Power Optical SM Transmitter/Receiver

FEATURES

- | SMPTE 297-2006 Compatible
- | Speed from 50 Mbps to 3Gbps with up to 50 km Single-mode Fiber
- | Distance up to 50 km for 3G-SDI
- | **Support Video Pathological Patterns for SD-SDI, HD-SDI and 3G-SDI**
- | Single Transmitter with Simplex LC
- | Single Receiver with Simplex LC
- | Based on Industry Standard SFP
- | TTL Laser Disable Input
- | TTL TX_Fault Output
- | TTL RX_LOS Output
- | Single +3.3 V Power Supply
- | RoHS-6 Compliant
- | 0 to 70°C Operation
- | Hot Pluggable
- | Class 1 Laser International Safety Standard IEC-60825 Compliant

DESCRIPTION

The SPS-9350V-1T1RG is a optical single mode transmitter/receiver module designed to transmit/receive optical serial digital signals as defined in SMPTE 297-2006. It supports from 50 Mbps to 3 Gbps and is specifically designed for transmitted the SMPTE 259M, SMPTE 344M, SMPTE 292M and SMPTE 424M SDI pathological patterns. It is with the SFP 20-pin connector to allow hot plug capability.. It is with 1550 nm DFB laser transmitters. The transmitter can transmit signal from 50 Mbps to 3 Gbps with up to 50 km of single-mode fiber. A maximum distance of 50 km is achievable with 3Gbps pathological signals.

LASER SAFETY

This single mode transceiver is a Class 1 laser product. It complies with IEC-60825 and FDA 21 CFR 1040.10 and 1040.11. The transceiver must be operated within the specified temperature and voltage limits. The optical ports of the module shall be terminated with an optical connector or with a dust plug.

APPLICATIONS

- | SMPTE 297-2006 Compliant Electrical-to-Optical Interfaces
- | High-density Video Routers

ORDER INFORMATION

P/No.	Type	Bit Rate (Mb/s)	TX		RX		Package	Temp (°C)	RoHS Compliant
			λ (nm)	Power (dBm)	λ (nm)	Sen. (dBm)			
SPS-9350V-1T1RG	1-TX+1-RX	50 to 3000	1550 DFB	4 to 0	1260/1620	0 to -20	LC SFP	0 to 70	Yes

RELATED PRODUCTS

P/No.	Type	Bit Rate (Mb/s)	TX		RX		Package	Temp (°C)	RoHS Compliant
			λ (nm)	Power (dBm)	λ (nm)	Sen. (dBm)			
SPS-9350V-2TG	2-TX	50 to 3000	1550 DFB	4 to 0			LC SFP	0 to 70	Yes
SPS-9350V-1TG	1-TX	50 to 3000	1550 DFB	4 to 0			LC SFP	0 to 70	Yes
SPS-9350V-2RG	2-RX	50 to 3000			1260/1620	0 to -20	LC SFP	0 to 70	Yes
SPS-9350V-1RG	1-RX	50 to 3000			1260/1620	0 to -20	LC SFP	0 to 70	Yes

LINK DISTANCE

Transmitter	Receiver	SDI	Bit Rate	Max. Link Distance (km)
SPS-9350V-2TG or SPS-9350V-1TG or SPS-9350V-1T1RG	SPS-9110V-2RG or SPS-9110V-1RG or SPS-9350V-1T1RG	3G-SDI	2.97Gbps	50
		HD-SDI	1.485Gbps	50
		SD-SDI	270Mbos	50

ABSOLUTE MAXIMUM RATINGS

Exposure to absolute maximum rating conditions for extended periods may affect device reliability.

Absolute Maximum Ratings					
Parameter	Symbol	Min	Max	Units	Notes
Storage Temperature	Tstg	-40	85	°C	
Operating Case Temperature	Tc	0	70	°C	
Power Supply Voltage	Vcc	0	4	V	
ESD Tolerance on all pins			1	KV HBM	
Relative Humidity	---	5	95	% RH	non-condensing

Recommended Operating Conditions					
Parameter	Symbol	Min	Typ	Max	Units / Notes
Power Supply Voltage	Vcc	3.13	3.3	3.47	V
Operating Case Temperature	Tc	0		70	°C
Baud Rate		50		3000	Mb/s
Power Supply Current	Icc		200	300	mA

Transmitter Specifications (0°C < Tc < 70°C, 3.13V < Vcc < 3.47V)						
Parameter	Symbol	Min	Typ	Max	Units	Notes
Optical						
Optical Transmit Power	Po	0		4	dBm	1
Output Center Wavelength	λ	1480	1550	1580	nm	
Output Spectrum Width	Δλ	---		1	nm	-20 dB width
Side Mode Suppression Ratio	SMSR	30			dB	
Extinction Ratio	ER	5	7.5		dB	
Relative Intensity Noise	RIN			-120	dB/Hz	
Optical Rise Time / Fall Time	tr / tf			135	ps	2, SMPTE 424M
				270	ps	2, SMPTE 292M
				800	ps	2, SMPTE 344M
				1.5	ns	2, SMPTE 259M
Electrical						
Differential Input Voltage	V _{IH} - V _{IL}	200		1200	mVp-p	AC coupled input
Disable Input Voltage -- Low	V _{TDIS,L}	0		0.8	V	TX Output Enabled
Disable Input Voltage -- High	V _{TDIS,H}	2.0		Vcc+0.3	V	TX Output Disabled
Output TX_Fault -- Low	V _{OL}	0		0.5	V	
Output TX_Fault -- High	V _{OH}	2.5		Vcc+0.3	V	
SCL, SDA	V _{OH}	2.5		Vcc+0.3	V	
	V _{OL}	0		0.5	V	

1. Output power is power coupled into a 9/125 μm single mode fiber.
2. 20% to 80%, unfiltered.

Receiver Specifications (0°C < Tc < 70°C, 3.13V < Vcc < 3.47V)						
Parameter	Symbol	Min	Typ	Max	Units	Notes
Optical						
Wavelength of Operation		1260	---	1620	nm	
Sensitivity for SMPTE 424M 2.97 Gb/s	Sen	0	---	-18	dBm	Pathological
		0	---	-20	dBm	PRBS 2 ²³ -1, BER=1E-12
Sensitivity for SMPTE 292M 1.485 Gb/s	Sen	0	---	-20	dBm	Pathological
		0	---	-21	dBm	PRBS 2 ²³ -1, BER=1E-12
Signal Detect -- Asserted	Pa	---	---	-20	dBm	Transition: low to high
Signal Detect -- Deasserted	Pd	-29	---	---	dBm	Transition: high to low
Signal detect -- Hysteresis		1		6	dB	

Optical Return Loss			-27		dB	
Electrical						
CML Output (Differential)		550	660	850	mVp-p	AC coupled output
Optical Rise Time / Fall Time	tr / tf			135	ps	3, SMPTE 424M
				270	ps	3, SMPTE 292M
				800	ps	3, SMPTE 344M
				1.5	ns	3, SMPTE 259M
Output LOS Voltage -- Low	V _{OL}	0		0.5	V	I _{OL} =-1.6mA, 1 TTL unit load
Output LOS Voltage -- High	V _{OH}	2.5		V _{CC} +0.3	V	I _{OH} =40μA, 1 TTL unit load
SCL, SDA	V _{OH}	2.5		V _{CC} +0.3	V	
	V _{OL}	0		0.5	V	

3. 20% to 80%, unfiltered.

MODULE DEFINITION

Module Definition	PIN 5	PIN 6	Interpretation by Host
4	SCL	SDA	Serial module definition protocol

Module Definition 4 specifies a serial definition protocol. For this definition, upon power up, SCL and SDA appear as no connector (NC). When the host system detects this condition, it activates the serial protocol. The protocol uses the 2-wire serial CMOS E²PROM protocol of the ATMEL AT24C01A/02/04 family of components.

CONNECTION DIAGRAM

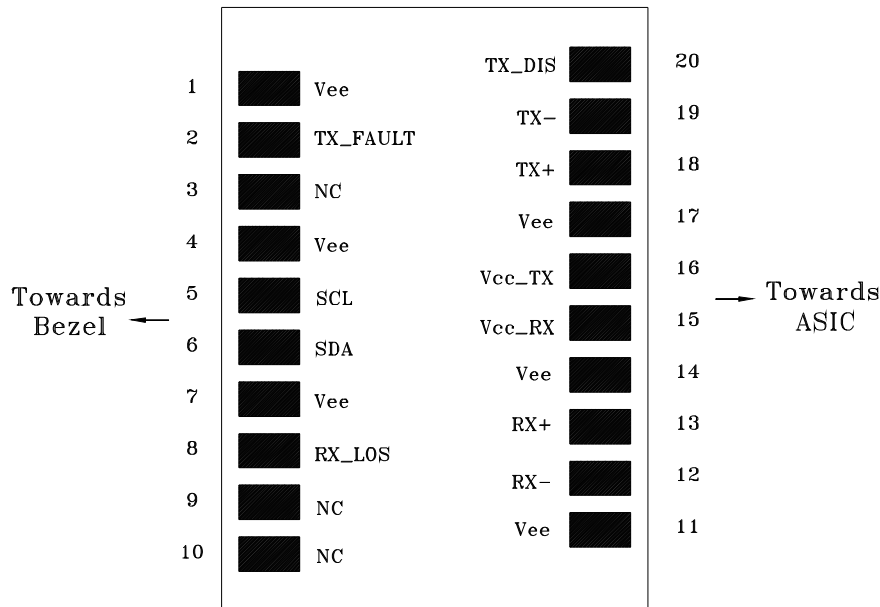

PIN	Name	Function	Notes
1	Vee	Signal Ground	
2	TX_Fault	Transmitter Fault Indicator (Active high, open-drain)	
3	NC	No Connection	
4	Vee	Signal Ground	
5	SCL	Serial I ² C Clock	
6	SDA	Serial I ² C Data	
7	Vee	Signal Ground	
8	RX_LOS	Receiver Loss of Signal Indicator (Active high, open-drain)	
9	NC	No Connection	
10	NC	No Connection	
11	Vee	Signal Ground	
12	RX-	Negative Differential Output	
13	RX+	Positive Differential Output	
14	Vee	Signal Ground	
15	Vcc RX	Power Supply	+3.3V±5%, Internal connected
16	Vcc TX	Power Supply	
17	Vee	Signal Ground	
18	TX+	Positive Transmitter Data In	AC coupled differential lines with 100 ohm differential termination inside the module
19	TX-	Negative Transmitter Data In	
20	TX_DIS	Transmitter Disable	Internal 4.7 kΩ pull-up. The bias current and modulation current are turned off if TX1_DIS = HIGH.

RECOMMENDED CIRCUIT SCHEMATIC

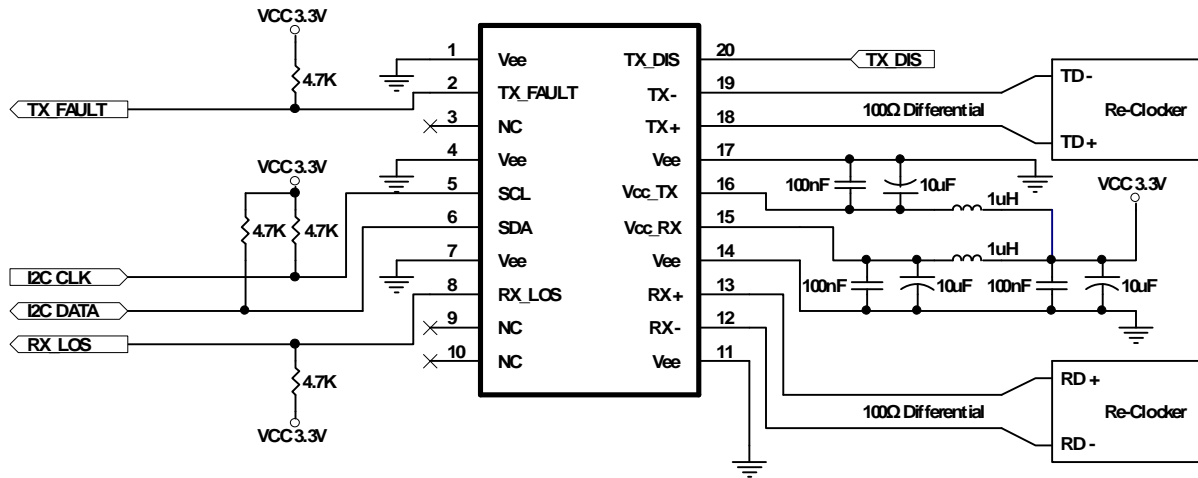

1. Consult the Chipset manufacturer's applications information for biasing required for TX outputs. Some chipset outputs are internally biased and may not need external bias resistor.

PACKAGE DIAGRAM (Units in mm)

Top View

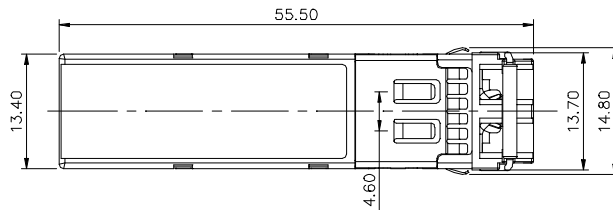

Front View

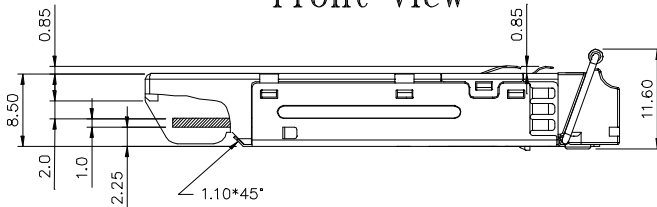

LATCH COLOR
BLUE

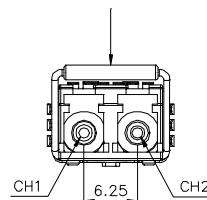

Side View

Bottom View

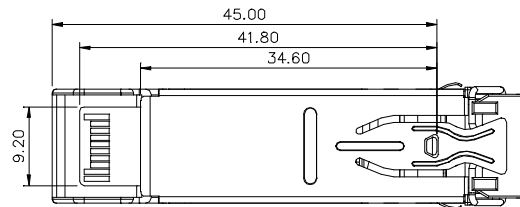

REVISION HISTORY

Version	Subject	Release Date
1.0	Initial datasheet	2009/3/1