

SPS-83120G

(RoHS Compliant)

3.3V / 1550 nm / 4.25 Gbps LC SFP SINGLE-MODE TRANSCEIVER

FEATURES

- | Up to 4.25 Gbps Bi-directional Data Links
- | Hot-Pluggable SFP Footprint LC Optical Transceiver
- | Small Form-Factor Pluggable (SFP) MSA compatible
- | Compliance with Fibre Channel FC-PI 400/200/100-SM-LC-L
- | 1550 nm DFB LD Transmitter
- | High Sensitivity APD Receiver
- | 30 dB Power Budget at Least
- | AC/AC Coupling according to MSA
- | **Up to 120 km Transmission**
- | Single +3.3 V Power Supply
- | RoHS Compliant
- | 0 to 70°C Operating
- | Class 1 Laser International Safety Standard IEC-60825 Compliant

APPLICATIONS

- | Tri-rate 1.063/2.125/4.25 Gb/s Fibre Channel
- | 1.25 Gb/s 1000 BASE Ethernet

DESCRIPTION

The SPS-83120G series single mode transceiver is small form factor pluggable module for bi-directional serial optical data communications such as 4x/2x/1x Fibre Channel and 1000BASE Ethernet. It is with the SFP 20-pin connector to allow hot plug capability. This module is designed for single mode fiber and operates at a nominal wavelength of 1550 nm. The transmitter section uses a 1550 nm multiple quantum well DFB laser and is a class 1 laser compliant according to International Safety Standard IEC-60825. The receiver section uses an integrated InGaAs detector preamplifier (IDP) mounted in an optical header and a limiting post-amplifier IC.

LASER SAFETY

This single mode transceiver is a Class 1 laser product. It complies with IEC-60825 and FDA 21 CFR 1040.10 and 1040.11. The transceiver must be operated within the specified temperature and voltage limits. The optical ports of the module shall be terminated with an optical connector or with a dust plug.

ORDER INFORMATION

P/No.	Bit Rate (Gb/s)	FC-PI	Distance (km)	Wavelength (nm)	Package	Temp. (°C)	TX Power (dBm)	RX Sens. (dBm)	RoHS Compliant
SPS-83120G	4 / 2 / 1	400/200/100	120	1550 DFB	LC SFP	0 to 70	6 to 3	-27	Yes

Absolute Maximum Ratings

Parameter	Symbol	Min	Max	Units	Notes
Storage Temperature	Tstg	-40	85	°C	
Case Operating Temperature	Topt	0	70	°C	
Power Supply Voltage	Vcc	-0.5	3.6	V	

Recommended Operating Conditions

Parameter	Symbol	Min	Typ	Max	Units / Notes
Power Supply Voltage	Vcc	3.13	3.3	3.47	V
Case Operating Temperature	Topt	0		70	°C
Power Supply Current	I _{CC(TX+RX)}		200	300	mA
Data Rate		1.0625		4.25	Gb/s

Transmitter Specifications (0°C < Topr < 70°C, 3.13V < Vcc < 3.47V)						
Parameter	Symbol	Min	Typ	Max	Units	Notes
Optical						
Optical Transmit Power	Po	3	---	6	dBm	1
Optical Modulation Amplitude@4.25Gb/s	OMA	1600	---		μW	
Output Center Wavelength	λ	1530		1570	nm	
Output Spectrum Width	Δλ	---		1	nm	-20 dB Width
Side Mode Suppression Ratio	SMSR	30			dB	
Optical Rise / Fall Time	t _r /t _f			90	ps	20 % to 80%,unfiltered
Relative Intensity Noise	RIN			-120	dB/Hz	
Electrical						
Data Input Current – Low	I _{IL}	-350			μA	
Data Input Current – High	I _{IH}			350	μA	
Differential Input Voltage	V _{IH} - V _{IL}	0.5		2.4	V	Peak-to-Peak
TX Disable Input Voltage – Low	T _{DIS,L}	0		0.5	V	2
TX Disable Input Voltage – High	T _{DIS,H}	2.0		Vcc	V	2
TX Disable Assert Time	T _{ASSERT}			10	μs	
TX Disable Deassert Time	T _{DEASSERT}			1	ms	
TX Fault Output Voltage -- Low	T _{FaultL}	0		0.5	V	3
TX Fault Output Voltage -- High	T _{FaultH}	2.0		Vcc+0.3	V	3

1. Output power is power coupled into a 9/125 μm single mode fiber.
2. There is an internal 4.7K to 10K ohm pull-up resistor to VccTX.
3. Open collector compatible, 4.7K to 10K ohm pull-up to Vcc (Host Supply Voltage).

Receiver Specifications (0°C < Topr < 70°C, 3.13V < Vcc < 3.47V)						
Parameter	Symbol	Min	Typ	Max	Units	Notes
Optical						
Sensitivity @4.25Gb/s	Sens1			2.6	μW	4
				-27	dBm	5
Sensitivity @2.125 / 1.063Gb/s	Sens2			2.6	μW	4
				-27	dBm	5
Maximum Input Power	Pin	-9			dBm	
Signal Detect -- Asserted	Pa	---		-27	dBm	Transition: low to high
Signal Detect -- Deasserted	Pd	-40	---	---	dBm	Transition: high to low
Signal detect -- Hysteresis		1.0	---		dB	
Wavelength of Operation		1260	---	1600	nm	
Electrical						
Differential Output Voltage	V _{OH} - V _{OL}	0.6		2.0	V	
Output LOS Voltage -- Low	V _{OL}	0		0.5	V	6
Output LOS Voltage -- High	V _{OH}	2.0		Vcc+0.3	V	6

4. Measured at PRBS 2⁷-1 at BER 1E-12.
5. Represents sensitivity based on OMA spec, as corrected to incoming Extinction Ratio of 9 dB. For example, an OMA of 2.6 μW is approximately equal to an average power of -27.7 dBm, average with an Extinction ratio of 9 dB.
6. Open collector compatible, 4.7K to 10K ohm pull-up to Vcc (Host Supply Voltage).

CONNECTION DIAGRAM

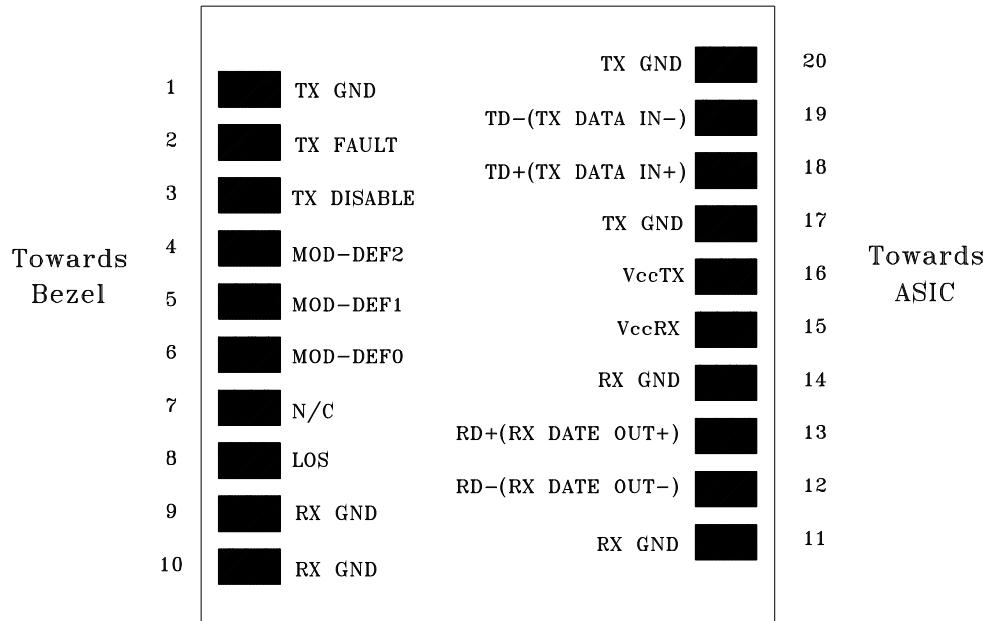

PIN	Signal Name	Description	PIN	Signal Name	Description
1	TX GND	Transmitter Ground	11	RX GND	Receiver Ground
2	TX Fault	Transmitter Fault Indication	12	RX DATA OUT-	Inverse Receiver Data Out
3	TX Disable	Transmitter Disable (Module disables on high or open)	13	RX DATA OUT+	Receiver Data Out
4	MOD-DFE2	Modulation Definition 2 – Two wires serial ID Interface	14	RX GND	Receiver Ground
5	MOD-DEF1	Modulation Definition 1 – Two wires serial ID Interface	15	Vcc RX	Receiver Power – 3.3V±5%
6	MOD-DEF0	Modulation Definition 0 – Ground in Module	16	Vcc TX	Transmitter Power – 3.3V±5%
7	N/C	Not Connected	17	TX GND	Transmitter Ground
8	LOS	Loss of Signal	18	TX DATA IN+	Transmitter Data In
9	RX GND	Receiver Ground	19	TX DATA IN-	Inverse Transmitter Data In
10	RX GND	Receiver Ground	20	TX GND	Transmitter Ground

Module Definition

Module Definition	MOD-DEF2 PIN 4	MOD-DEF1 PIN 5	MOD-DEF0 PIN 6	Interpretation by Host
4	SDA	SCL	LV-TTL Low	Serial module definition protocol

Module Definition 4 specifies a serial definition protocol. For this definition, upon power up, MOD-DEF(1:2) appear as no connector (NC) and MOD-DEF(0) is TTL LOW. When the host system detects this condition, it activates the serial protocol. The protocol uses the 2-wire serial CMOS E²PROM protocol of the ATMEL AT24C01A/02/04 family of components.

RECOMMENDED CIRCUIT SCHEMATIC

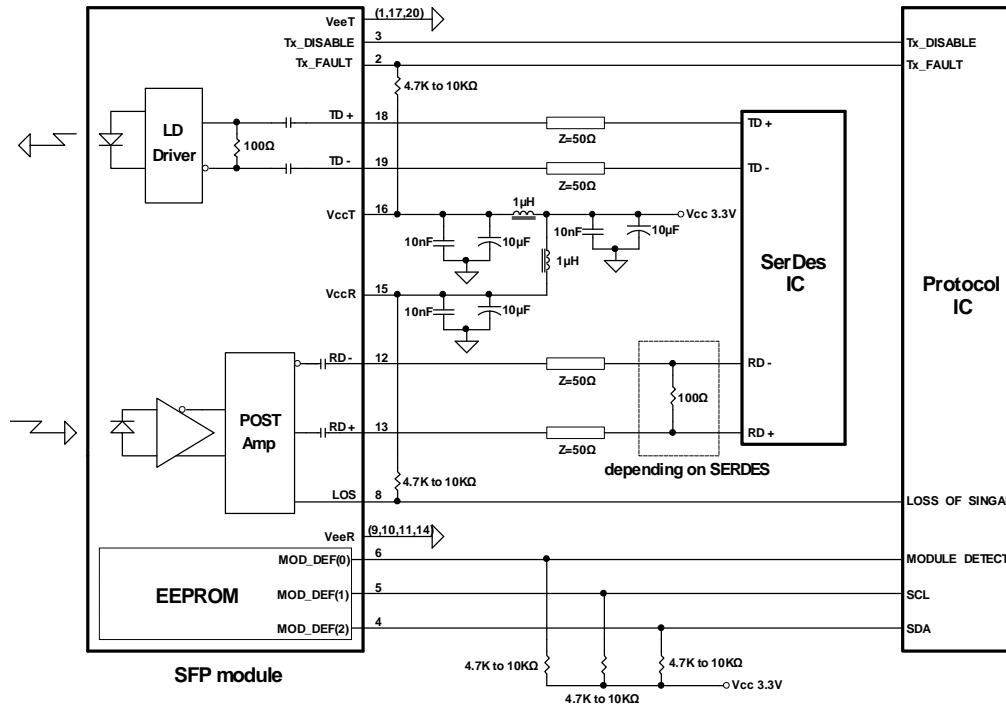

PACKAGE DIAGRAM

Units in mm

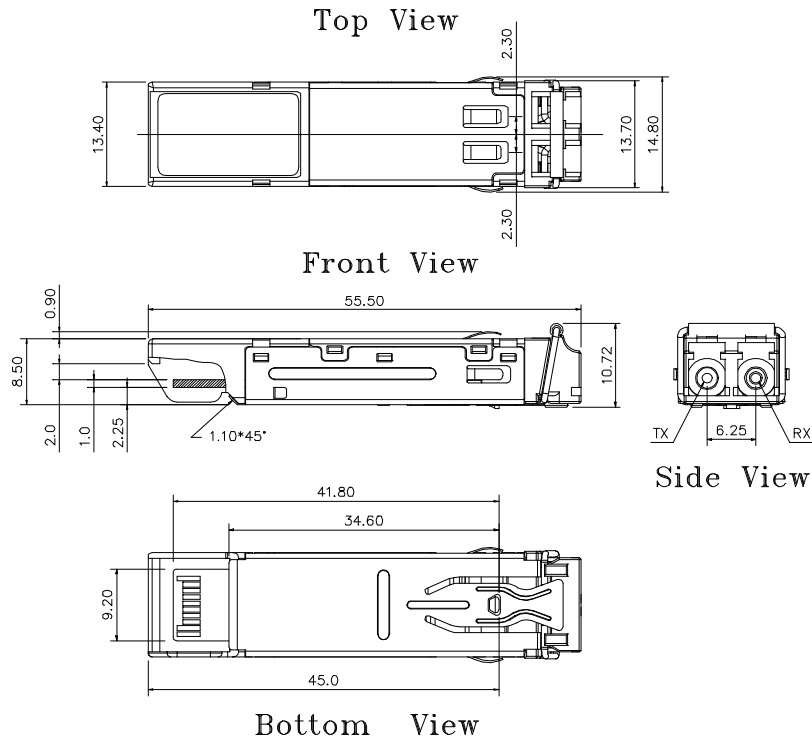

Note: Specifications subject to change without notice.

Revision History

Version	Subject	Release Date
1.0	Initial datasheet	2007/8/1