

FL-5660 / PT-3610 SERIES

(RoHS Compliant)

8-Pin Ethernet Single-Mode Optical Transmitter / Receiver

FEATURES

- * Distance up to 20 km at signal rates of 1 to 20 MBd
- * 1550 nm wavelength emission
- * Single-mode fiber operation
- * Wave solder and aqueous wash process compatible
- * Panel mount ST connectors (FL-5660 / PT-3610)
- * Panel mount FC connectors (FL-5660F / PT-3610F)
- * Industrial standard 8-pin configuration
- * RoHS Compliant



APPLICATION

- * Single-mode extensions to Ethernet (10-Base-F) links
- * Single-mode connection

DESCRIPTION

FL-5660 / PT-3610 series is specified designed for the Ethernet single-mode transmitter / receiver application.

FL-5660 / FL-5660F ELECTRICAL AND OPTICAL CHARACTERISTICS (T _C =25 °C)						
Symbol	Parameter	Test Conditions	Min.	Typ.	Max.	Unit
I _{th}	Threshold Current	CW	---	12	20	mA
V _{OP}	Operating Voltage	I _{op} =40mA, SM fiber	---	1.2	1.5	V
P _f	Fiber Coupled Power		-14	---	-6	dBm
λ	Peak Wavelength		1510	1550	1580	nm
Δλ	Spectrum Width		---	---	5	nm

PT-3610 / FL-3610F ELECTRICAL AND OPTICAL CHARACTERISTICS (T _C =25 °C)						
Symbol	Parameter	Test Conditions	Min.	Typ.	Max.	Unit
Sen	Sensitivity	1 to 20 MBd, SM fiber			-34	dBm
P _{in, sat}	Saturation		-5	0	---	dBm
V _{CC}	Supply Voltage		4.75	5	5.25	V
I _{CC}	Supply Current		20	25	35	mA

Recommended Operating Conditions						
Symbol	Parameter	Test Conditions	Min.	Typ.	Max.	Unit
T _{opr}	Operating Temperature		0		70	°C
T _{stg}	Storage Temperature		-40		85	°C

PINOUT DESCRIPTION

MECHANICAL DIMENSION (mm)

1) FL-5660 / PT-3610 (Panel mount ST connectors)

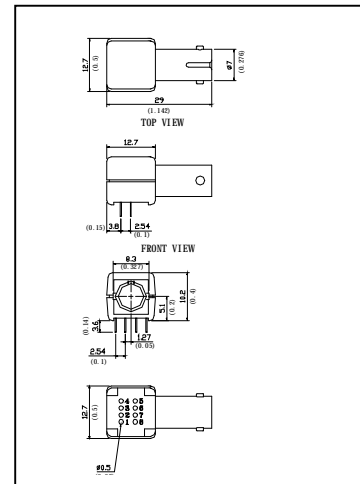
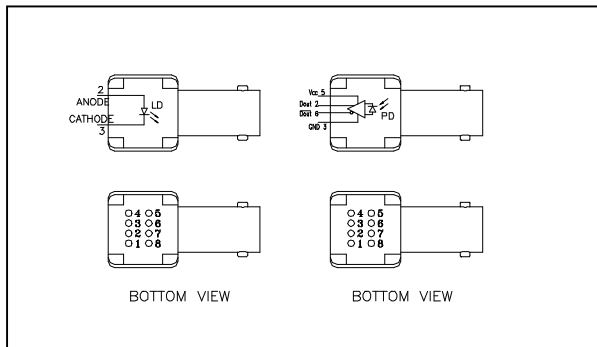

2) FL-5660F / PT-3610F (Panel mount FC connectors)

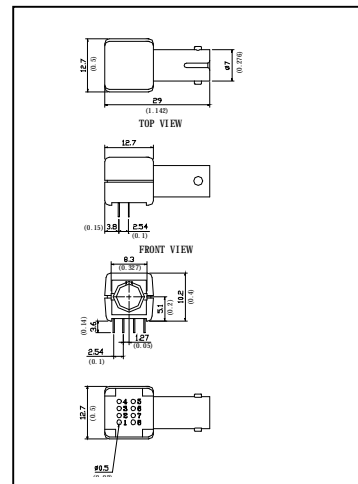
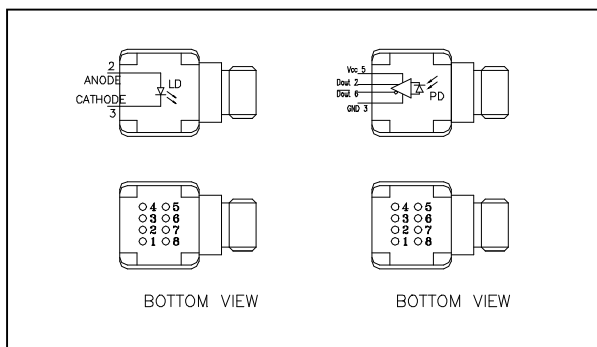

PIN ASSIGNMENT

FL-5660 / FL-5660F

PIN	Function
2	LD Anode
3	LD Cathode
1, 4, 5, 6, 7, 8	No Connect

PT-3610 / PT-3610F

PIN	Function
2	Dout
3	GND
5	Vcc
6	Dout Bar
1, 4, 7, 8	No Connect

Note: Specifications subject to change without notice.

ORDER INFORMATION

Transmitter	Receiver	Distance (km)	Fiber	Data Rate (MBd)	Connector
FL-3620 / FL-3620F	PT-3610 / PT-3610F	20	SM	1 to 20	ST / FC
FL-3640 / FL-3640F	PT-3610 / PT-3610F	40	SM	1 to 20	ST / FC
FL-5660 / FL-5660F	PT-3610 / PT-3610F	60	SM	1 to 20	ST / FC
FL-5680 / FL-5680F	PT-3610 / PT-3610F	80	SM	1 to 20	ST / FC

Revision History

Version	Subject	Release Date
1.0	Initial datasheet	2002/6/1
2.0	Combine FL-5660/PT-3610 & FL-5660G/PT-3610G in one data sheet	2007/12/1