

BTR-3721G

(RoHS Compliant)

1550 nm TX / 1310 nm RX , 3.3V / 125 Mbps Single-Fiber Transceiver

FEATURES

- | Single Fiber Bi-Directional Transceiver
- | 1550 nm LD Transmitter
- | 1310 nm Receiver
- | Distance Up to 20 km
- | Industry Standard 1 x 9 Footprint
- | Single +3.3 V Power Supply
- | PECL Differential Inputs and Outputs
- | 0 to 70°C Operating Temperature
- | **RoHS Compliant**
- | Wave Solderable and Aqueous Washable
- | Class 1 Laser International Safety Standard IEC-60825 Compliant

APPLICATIONS

- | Fast Ethernet 100 Mb/s Links
- | SONET/SDH Equipment Interconnect

DESCRIPTION

The BTR-3721G series is high performance module for single fiber communications by using 1550 nm transmitter and 1310 nm receiver. The transmitter section uses a multiple quantum well laser and is a class 1 laser compliant according to International Safety Standard IEC-60825. The receiver section uses an integrated 1550 nm detector preamplifier (IDP) mounted in an optical header and a limiting post-amplifier IC. A PECL logic interface simplifies interface to external circuitry.

LASER SAFETY

This single mode transceiver is a Class 1 laser product. It complies with IEC-60825 and FDA 21 CFR 1040.10 and 1040.11. The transceiver must be operated within the specified temperature and voltage limits. The optical ports of the module shall be terminated with an optical connector or with a dust plug.

Absolute Maximum Ratings					
Parameter	Symbol	Min	Max	Units	Notes
Storage Temperature	Tstg	-40	85	°C	
Operating Temperature	Topr	0	70	°C	
Soldering Temperature	---		260	°C	10 seconds on leads only
Power Supply Voltage	Vcc	0	4.5	V	
Input Voltage	---	GND	Vcc	V	
Output Current	Iout	0	30	mA	

Recommended Operating Conditions					
Parameter	Symbol	Min	Typ	Max	Units
Power Supply Voltage	Vcc	3.13	3.3	3.47	V
Operating Temperature	Topr	0		70	°C
Data Rate			125		Mb/s
Power Supply Current				240	mA

Transmitter Specifications (0°C < Topr < 70°C, 3.13V < Vcc < 3.47V)						
Parameter	Symbol	Min	Typ	Max	Units	Notes
Optical						
Optical Transmit Power	Po	-14	---	-8	dBm	1
Output Center Wavelength	λ	1480		1580	nm	
Output Spectrum Width	$\Delta\lambda$	---	---	3	nm	RMS (σ)
Extinction Ratio	ER	8.2	---	---	dB	
Output Eye	Compliant with Bellcore GR-253-CORE and ITU recommendation G.957					
Optical Rise Time	t _r			2	ns	10% to 90% Values
Optical Fall Time	t _f			2	ns	10% to 90% Values
Electrical						
Data Input Current – Low	I _{IL}	-350			μ A	
Data Input Current – High	I _{IH}			350	μ A	
Differential Input Voltage	V _{IH} - V _{IL}	300			mV	
Data Input Voltage – Low	V _{IL} - V _{CC}	-2.0		-1.58	V	2
Data Input Voltage -- High	V _{IH} - V _{CC}	-1.1		-0.74	V	2

- Notes: 1. Output power is power coupled into a 9/125 μ m single mode fiber.
 2. These inputs are compatible with 10K, 10KH and 100K ECL and PECL inputs.

Receiver Specifications (0°C < Topr < 70°C, 3.13 V < Vcc < 3.47V)						
Parameter	Symbol	Min	Typ	Max	Units	Notes
Optical						
Sensitivity	---	---	---	-32	dBm	1
Maximum Input Power	Pin	-8	---	---	dBm	
Signal Detect -- Asserted	Pa	---	---	-32	dBm	Transition: low to high
Signal Detect -- Deasserted	Pd	-45	---	---	dBm	Transition: high to low
Signal detect -- Hysteresis		1.0	---	4.0	dB	
Wavelength of Operation		1260		1360	nm	2
Electrical						
Data Output Voltage – Low	V _{OL} - V _{CC}	-2.0		-1.58	V	3
Data Output Voltage – High	V _{OH} - V _{CC}	-1.1		-0.74	V	3
SD Output Voltage -- Low	V _{OL} - V _{CC}	-2.0		-1.58	V	3
SD Output Voltage -- High	V _{OH} - V _{CC}	-1.1		-0.74	V	3

- Notes: 1. Minimum sensitivity and saturation levels at BER 1E-10 for a 2²³-1 PRBS.
 2. At least 30 dB optical isolation for the wavelength 1480 to 1580 nm.
 3. These inputs are compatible with 10K, 10KH and 100K ECL and PECL outputs.

CONNECTION DIAGRAM

Receiver Signal Ground	1 (Rx GND)	○
Receiver Data Out	2 (RD+)	N/C
Receiver Data Out Bar	3 (RD-)	
Signal Detect	4 (SD)	
Receiver Power Supply	5 (Rx Vcc)	TOP VIEW
Transmitter Power Supply	6 (Tx Vcc)	
Transmitter Data In Bar	7 (TD-)	
Transmitter Data In	8 (TD+)	N/C
Transmitter Signal Ground	9 (Tx GND)	○

PIN	Symbol	Notes
1	Rx GND	Directly connect this pin to the receiver ground plane
2	RD+	See recommended circuit schematic
3	RD-	See recommended circuit schematic
4	SD	Active high on this indicates a received optical signal
5	Rx Vcc	+3.3V dc power for the receiver section
6	Tx Vcc	+3.3V dc power for the transmitter section
7	TD-	See recommended circuit schematic
8	TD+	See recommended circuit schematic
9	Tx GND	Directly connect this plan to the transmitter ground plane

RECOMMENDED CIRCUIT SCHEMATIC

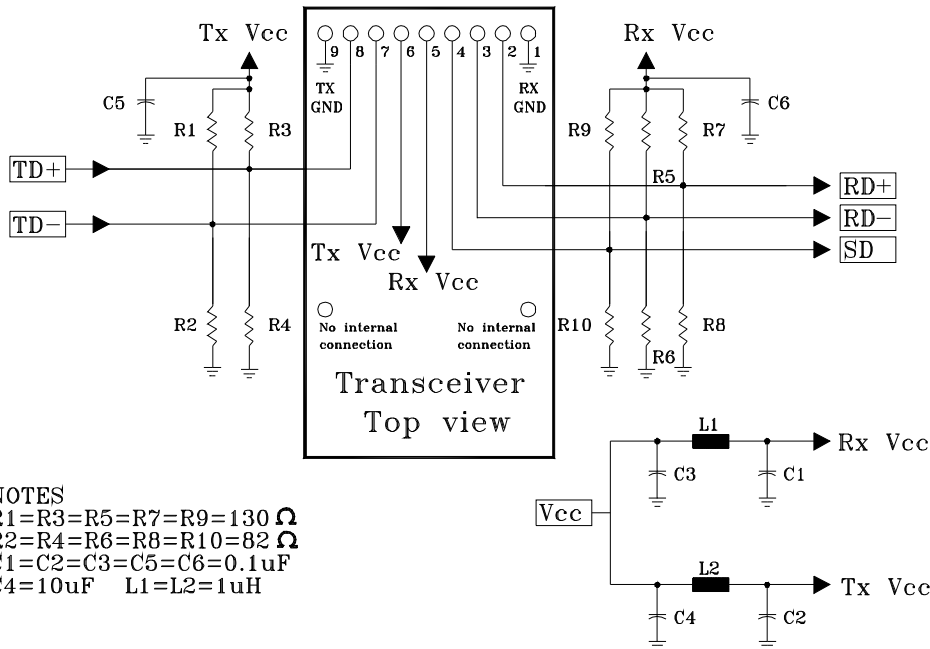

The split-load terminations for ECL signals need to be located at the input of devices receiving those ECL signals. The power supply filtering is required for good EMI performance. Use short tracks from the inductor L1/L2 to the module Rx Vcc and Tx Vcc. A GND plane under the module is required for good EMI and sensitivity performance.

PACKAGE DIAGRAM

Units in mm

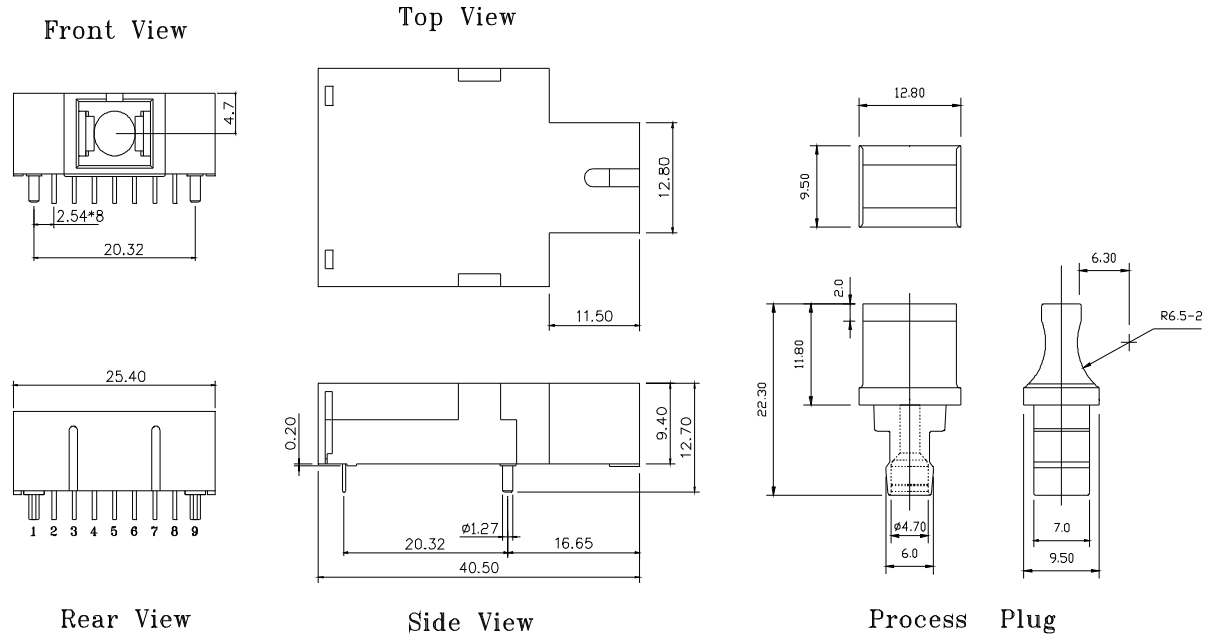

Note: Specifications subject to change without notice.